

xantrex™

A MISSION CRITICAL ELECTRONICS BRAND

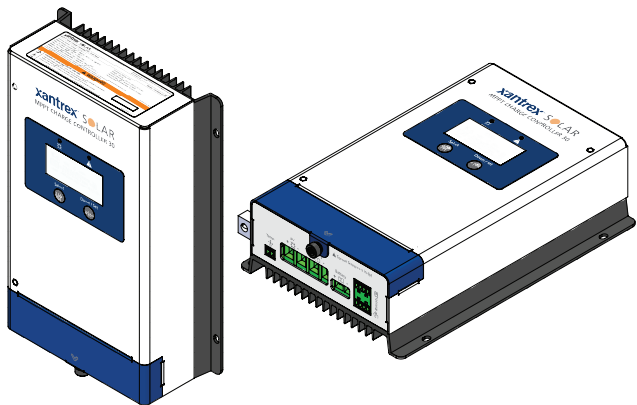

Owner's Guide

**30A MPPT Solar Charge Controller
(12/24VDC)**

710-3024-01

Copyright © 2019 Xantrex LLC. All Rights Reserved.

All trademarks are owned by Xantrex LLC and its affiliates.

Exclusion for Documentation

UNLESS SPECIFICALLY AGREED TO IN WRITING, SELLER (A) MAKES NO WARRANTY AS TO THE ACCURACY, SUFFICIENCY OR SUITABILITY OF ANY TECHNICAL OR OTHER INFORMATION PROVIDED IN ITS MANUALS OR OTHER DOCUMENTATION; (B) ASSUMES NO RESPONSIBILITY OR LIABILITY FOR LOSSES, DAMAGES, COSTS OR EXPENSES, WHETHER SPECIAL, DIRECT, INDIRECT, CONSEQUENTIAL OR INCIDENTAL, WHICH MIGHT ARISE OUT OF THE USE OF SUCH INFORMATION. THE USE OF ANY SUCH INFORMATION WILL BE ENTIRELY AT THE USER'S RISK; AND (C) REMINDS YOU THAT IF THIS MANUAL IS IN ANY LANGUAGE OTHER THAN ENGLISH, ALTHOUGH STEPS HAVE BEEN TAKEN TO MAINTAIN THE ACCURACY OF THE TRANSLATION, THE ACCURACY CANNOT BE GUARANTEED. APPROVED CONTENT IS CONTAINED WITH THE ENGLISH LANGUAGE VERSION WHICH IS POSTED AT <http://www.xantrex.com>.

Document Number: 975-1011-01-01 **Rev B Date:** Oct 2019

Product Name and Part Number

30A MPPT Solar Charge Controller (12/24VDC) | 710-3024-01

Contact Information

Telephone: +1-800-670-0707 / +1-408-987-6030

Email: customerservice@xantrex.com,
<http://www.xantrex.com/power-products-support/>

Web: <http://www.xantrex.com>

IMPORTANT SAFETY INFORMATION

READ AND SAVE THIS OWNER'S GUIDE FOR FUTURE REFERENCE.

Read these instructions carefully and look at the equipment to become familiar with the device before installing, operating, configuring, maintaining, and troubleshooting it. The following special messages may appear throughout this documentation or on the equipment to warn of potential hazards or to call attention to information that clarifies or simplifies a procedure.



The addition of either symbol to a "Danger" or "Warning" safety label indicates that an electrical hazard exists which will result in personal injury if the instructions are not followed.



This is the safety alert symbol. It is used to alert you to potential personal injury hazards. Obey all safety messages that follow this symbol to avoid possible injury or death.

Table 1 Abbreviations and acronyms

AGM	Absorbent Glass Mat lead-acid battery
BTS	Battery Temperature Sensor
BMS	Battery Management System
LCD	Liquid Crystal Display
LFP, LiFePO ₄	Lithium-ion Iron Phosphate
MPPT	Maximum Power Point Tracking
PV	Photovoltaic
SOC	State-of-Charge

Product Safety Information

1. Before using the solar charge controller, read all instructions and cautionary markings on the solar charge controller's components, the batteries, and all appropriate sections of this guide.
2. Use of accessories not recommended or sold by the manufacturer may result in injury to persons, a risk of electric shock, or a risk of fire.
3. The solar charge controller is designed to be connected to your DC electrical systems. The manufacturer recommends that all wiring be done by a certified PV technician or electrician to ensure adherence to the local and national electrical codes applicable in your jurisdiction.
4. To avoid a risk of fire and electric shock, make sure that existing wiring is in good condition and that wire is not undersized. Do not operate the solar charge controller with damaged or substandard wiring.
5. Do not operate the solar charge controller if it has been damaged in any way.
6. This solar charge controller does not have any user-serviceable parts. Do not disassemble the solar charge controller except where noted for connecting wiring and cabling. See your warranty for instructions on obtaining service. Attempting to service the solar charge controller yourself may result in a risk of electrical shock or fire.
7. To reduce the risk of electrical shock, disconnect all DC power sources from the solar charge controller before attempting any maintenance or cleaning or working on any components connected to the solar charge controller.
8. Do not expose the solar charge controller to rain, snow, or liquids of any type. This product is designed for dry-locations-use only. Damp environments will significantly shorten the life of this product and corrosion caused by dampness will not be covered by the product warranty.
9. To reduce the chance of short-circuits, always use insulated tools when installing or working with this equipment.

10. Remove personal metal items such as rings, bracelets, necklaces, and watches when working with electrical equipment.

DANGER

ELECTRICAL SHOCK AND FIRE HAZARD

Installation must be done by qualified personnel to ensure compliance with all applicable installation and electrical codes and regulations. Instructions for installing the Xantrex SOLAR MPPT Charge Controller are provided here for use by qualified personnel trained in Recreational Vehicle and Solar power systems.

Failure to follow these instructions will result in death or serious injury.

WARNING

ELECTRIC SHOCK, FIRE, AND EXPLOSION HAZARD

- Do not connect the charge controller to a residential electrical system.
- Do not ground any PV conductors. The charge controller has a common negative design.
- Use the charge controller with a 12 or 24 VDC nominal battery system only.

Failure to follow these instructions can result in death, serious injury, or equipment damage.

CAUTION

PHYSICAL INJURY HAZARD

This Xantrex SOLAR MPPT Charge Controller is not intended for use by persons (including children) with reduced physical, sensory, or mental capabilities or lack of experience and knowledge, unless they have been given supervision or instruction concerning use of the appliance by a person responsible for their safety. Children should be supervised to ensure that they do not play with the appliance.

Failure to follow these instructions can result in injury or equipment damage.

CAUTION

LITHIUM ION BATTERY TYPE HAZARD

Make sure to use a lithium ion battery pack that includes a certified Battery Management System (BMS) with built-in safety protocols. Follow the instructions published by the battery manufacturer.

Failure to follow these instructions can result in serious injury or equipment damage.

NOTICE

BATTERY DAMAGE

Do not mix battery types. The charge controller can only select one battery type setting for all batteries connected to both banks. All connected batteries should either be: Sealed (AGM) or Gel or Flooded or Lithium-ion.

Failure to follow these instructions can result in equipment damage.

End of Life Disposal

The Xantrex SOLAR MPPT Charge Controller is designed with environmental awareness and sustainability in mind. At the end of its useful life, the charge controller can be decommissioned and disassembled. Components which can be recycled must be recycled and those that cannot be recycled must be disposed of according to local, regional, or national environmental regulations.

Many of the electrical components used in the Xantrex SOLAR MPPT Charge Controller are made of recyclable material like steel, copper, aluminum, and other alloys. These materials can be auctioned off to traditional scrap metal recycling companies who resell reusable scraps.

Electronic equipment such as the circuit boards, connectors, and fuses can be broken down and recycled by specialized recycling companies whose goal is to avoid having these components end up in the landfill.

For more information on disposal, contact Xantrex.

TABLE OF CONTENTS

Important Safety Information	3
Product Safety Information	4
End of Life Disposal	8
INTRODUCTION	11
Features	12
Materials List	14
Front Panel and Connection Terminals	15
Maximum Power Point Tracking (MPPT)	17
Charge Controlling	18
Three-Stage Battery Charging	19
Equalization Charging	21
INSTALLATION	23
Safety Instructions	24
PV Array Requirements	25
Wiring Requirements	28
Mounting Requirements	30
Basic Installation Steps	31
OPERATION	37
LCD Display Panel	38
Function Buttons and LED Indicators	38
Event Indicators	40
Basic Operation	41
Automatic Browsing Status Screens	46
Battery Status and Types	47
Protection Features During Operation	49

TROUBLESHOOTING	51
Common Issues	52
Maintenance	53
SPECIFICATIONS	55
Accessory List	57
Mounting Dimensions	58

1 INTRODUCTION

Thank you for purchasing the Xantrex SOLAR MPPT Charge Controller. The Xantrex SOLAR MPPT Charge Controller is a high quality, 12/24V solar charge controller. It is designed to take solar energy and charge many types of 12V or 24V batteries using a smart charging algorithm integrated with maximum power point tracking.

This chapter includes the following topics:

Features	12
Materials List	14
Front Panel and Connection Terminals	15
Maximum Power Point Tracking (MPPT)	17
Charge Controlling	18
Three-Stage Battery Charging	19
Equalization Charging	21

Features

The charge controller is equipped with the following features:

1. Maximum power point tracking (MPPT) technology
 - Capable of ultra fast tracking speed including multiple power point peaks with a 99.5% efficiency rating.
 - The MPPT control algorithm maximizes effective rate and time energy harvesting.
 - Has a wide maximum power point operating voltage range.
2. Multi-function operation
 - Supports various battery types - the charge controller can charge Sealed (AGM), Gel, Flooded lead acid batteries, and Lithium-ion-based batteries.
 - Charging power and current limitation - the solar charge controller is protected from over-charging, input overloading, and short-circuiting.
 - Battery temperature compensation - with the optional Battery Temperature Sensor -BTS (PN: 708-0080), charging parameters are automatically adjusted for efficient charging of the battery.
 - Real-time energy statistics - energy use history is stored using on board memory and recalled for information purposes.
 - Overheating power reduction - full charging and load operation at a wide temperature range between -25 to 55 °C (lead-acid batteries), 0 to 55 °C (Lithium-ion battery), and dynamically reduces power output upon reaching beyond the temperature range limit.
3. Multiple interfaces
 - LCD Display - is located on the front panel of the unit and is equipped with control buttons.
 - LED Indicators - also located on the front panel of the unit to show charging, battery, and event status.

- Remote panel - available option [SOLAR MPPT Remote Panel (PN:710-0010)] for monitoring and setting parameters.
- Electrical ports - pairs of DC pos(+) and neg(-) terminals for PV and batteries.
- BTS port - for connecting the optional Battery Temperature Sensor -BTS (PN: 708-0080).

Materials List

The charge controller base package includes the following items:

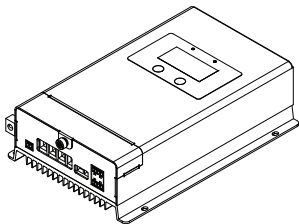

Optional Accessory

SOLAR MPPT Remote Panel (PN:710-0010)



Battery Temperature Sensor -BTS (PN: 708-0080)

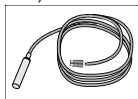

1	Xantrex SOLAR MPPT Charge Controller
2	Owner's Guide
3	Mounting screws

NOTE: If any of the items are missing, contact Xantrex or any authorized Xantrex dealer for replacement. See *Contact Information on page 1*.

IMPORTANT: Keep the carton and packing material in case you need to return the charge controller for servicing.

8	PV - DC [+] and [-] input terminals - Connects to a PV/solar panel. See also " <i>Basic Installation Steps</i> " on page 31.
9	Battery 1 - DC [+] and [-] output terminals - Connects to a 12/24V battery. See also " <i>Basic Installation Steps</i> " on page 31.
10	Battery 2 - DC [+] and [-] output terminals - Connects to a 12/24V battery. See also " <i>Basic Installation Steps</i> " on page 31.
11	Mounting holes - See <i>Mounting Requirements</i> on page 30.
12	Remote port - Connect the optional SOLAR MPPT Remote Panel (PN:710-0010). See also " <i>Wiring connections diagram</i> " on page 33.

Maximum Power Point Tracking (MPPT)

MPPT enables the charge controller to harvest the maximum energy available from the PV array and deliver it to the batteries.

The MPPT algorithm continuously adjusts the array operating voltage so that the array continuously operates at its maximum power point.

The solar charge controller applies a variable charging load on the array—shown by the power curve (solid line) in *Figure 1 on page 17*—until it finds the maximum wattage (the point at which both operating voltage and current can be maximized at the same time), as indicated by “MPP” in the same figure. The charge controller then holds the array at this point for as long as the array continues to produce the maximum power possible. As panel shading, cloud cover, and sunlight angle shift, the charge controller finds the new maximum power point without interrupting its output power flow.

Figure 1 MPPT Power Curve

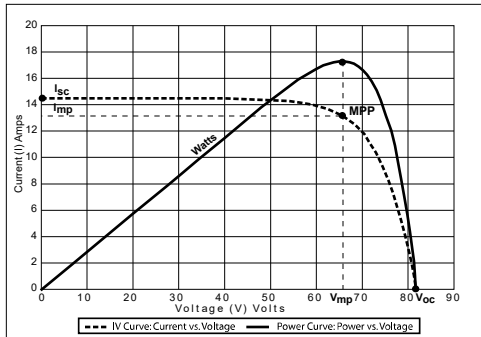

Charge Controlling

The charge controller can regulate PV array current for charging batteries at 12 and 24 volts.

Figure 2 PV Charge Controller

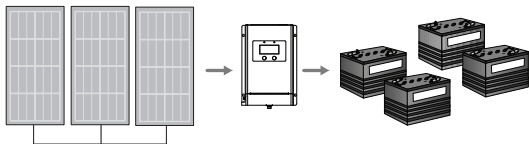

The charge controller controls how the batteries are charged by the DC source (the PV array).

When charging, the charge controller regulates the charging voltage and current based on the amount of DC power available from the PV array and the current state of charge of the battery.

The charge controller is able to charge a lower nominal-voltage battery from a higher-nominal voltage array. For example, the charge controller can charge a 12-volt battery from a 36-volt array. This gives flexibility for installers to use simpler wiring runs, smaller gauge PV cables, when wiring PV panels in-series without compromising the efficiency of a higher-voltage array.

The solar charge controller is not able to charge a higher-voltage battery from a lower-voltage array.

Table 2 Battery to PV Array Voltages

Battery System Voltage	Minimum PV Array Voltage	Maximum PV Array Voltage (Open Circuit)
12 V	15 V	100 V
24 V	27 V	

Three-Stage Battery Charging

The three-stage charging process results in more efficient charging compared to on-off relay type or constant voltage solid-state regulators. The final float stage reduces battery gassing, minimizes electrolyte loss, and ensures complete battery recharging. Battery voltage and current vary during the three-stage charging process as shown in *Figure 3*.

- Bulk Stage** During the bulk stage, the charge controller operates with a constant current, delivering maximum current to the batteries. When the battery voltage reaches the Absorption voltage setting, the controller automatically transitions to the absorption stage.
- Absorption Stage** During the absorption stage, the charge controller operates in Constant Voltage mode and the current falls gradually as charge is returned to the battery. The voltage limit in this stage is the Absorption Voltage setting.
- Float Stage** During the float stage, the voltage of the battery is held at the float voltage setting. Full current can be provided to the loads connected to the battery during the float stage from the PV array. When battery voltage drops below the ReCharge Volts setting for 1 minute, a new bulk stage cycle will be triggered.

Figure 3 Three-stage battery charging

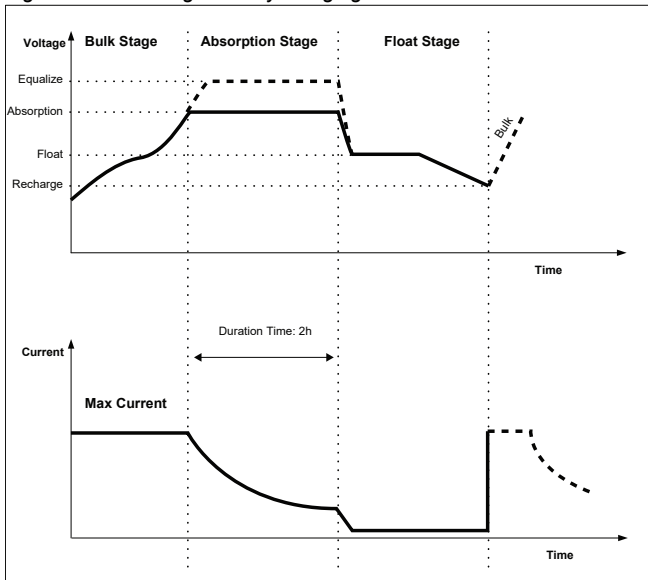

Equalization Charging

The charge controller can be used to provide the battery bank with an equalize charge.

Equalization is a deliberate overcharge designed to return each cell in the battery to optimum condition by reducing sulfation and stratification in the battery. The equalization charge is generally performed only on flooded, vented (non-sealed or “wet”) lead-acid batteries, as recommended by the battery manufacturer.

To avoid damaging your batteries, be sure to read all cautions and warnings concerning equalization charging.

This page is intentionally blank.

2 INSTALLATION

Before beginning your installation:

- Read this entire chapter so you can plan the installation from beginning to end.
- Assemble all the tools and materials you require for the installation.
- Be aware of all safety and electrical codes which must be met.

This chapter includes the following topics:

Safety Instructions	24
PV Array Requirements	25
Wiring Requirements	28
Mounting Requirements	30
Basic Installation Steps	31

Safety Instructions

WARNING

ELECTRICAL SHOCK AND FIRE HAZARD

- All wiring should be done by qualified personnel to ensure compliance with all applicable installation codes and regulations. Design the power system using a certified recreational vehicle and PV system designer and install using a certified RV technician/electrician.
- Comply with all applicable installation codes and regulations.
- Do not connect to power sources during installation.
- Connect only PV modules of the same size and rating to build a PV array. Mixing and matching different PV modules are not recommended.

Failure to follow these instructions can result in death, serious injury, or equipment damage

NOTICE

REVERSE POLARITY

- Ensure that the "+" and "-" poles on both the battery and PV are connected correctly.
- Check polarity at all terminals before making the final DC connection. Pos(+) (red) cable must connect to "+" pole; Neg (-) (black) cable must connect to "-" pole.

Failure to follow these instructions can result in non-operation of equipment.

PV Array Requirements

- Serial connection (string) of PV modules** - as the core component of the PV system, the charge controller could be suitable for various types of PV modules and maximize converting solar energy into electrical energy. According to the open circuit voltage (V_{OC}) and the maximum power point voltage (V_{Mpp}) of the Xantrex SOLAR MPPT Charge Controller, the series number of different types PV modules can be calculated. For reference, see *Table 3* and *Table 4*.
- Maximum PV array power** - the charge controller is capable of limiting the current and power during the charging process. When the charging current or power from a charging source exceeds the charge controller's rated charging current or power, the charge controller will automatically limit the incoming charging current or power to protect the charge controller.

The actual operation of PV array is as follows:

- **Condition 1:** Actual charging power of PV array \leq Rated charging power of charge controller.
- **Condition 2:** Actual charging current of PV array \leq Rated charging current of charge controller.

When the controller operates under *Condition 1* or *Condition 2*, it will carry out the charging according to the actual current or power. With this, the charge controller can work at the maximum power point of the PV array.

Table 3 PV Module String Configuration 1

System Voltage	36 Cell Voc < 23V		48 Cell Voc < 31V		54 Cell Voc < 34V		Thin-film Module
	Max	Ideal	Max	Ideal	Max	Ideal	Voc > 80V
12V	4	2	2	1	2	1	1
24V	4	3	2	2	2	2	1

Table 4 PV Module String Configuration 2

System Voltage	60 Cell Voc < 38V		72 Cell Voc < 46V		96 Cell Voc < 62V	
	Max	Ideal	Max	Ideal	Max	Ideal
12V	2	1	2	1	1	1
24V	2	2	2	1	1	1

- **Condition 3:** Actual charging power of PV array > Rated charging power of charge controller.
- **Condition 4:** Actual charging current of PV array > Rated charging current of charge controller.

When the charge controller operates under *Condition 3* or *Condition 4*, it will carry out the charging according to the rated current or power.

NOTICE

EQUIPMENT DAMAGE

Check that the total open circuit voltage (Voc) of the PV array multiplied by 1.25 (a 25% safety factor) must not exceed the charge controller's maximum PV voltage rating of 100V.

Failure to follow these instructions can result in charge controller damage.

Generally speaking, if the output power of the PV array exceeds the rated charging power of a charge controller, then the charge controller will be limited according to its rated charging power. The maximum power of the PV array shall not be greater than 1.5 times the rated charging power of the charge controller. If the maximum power of the PV array exceeds the rated charging power of charge controller too much, it will not only be under-utilizing the PV modules, but it also increases the open-circuit voltage of the PV array especially with changes in ambient temperatures. In which

case, the probability of charge controller damage increases. Therefore, it is important to configure the PV power system reasonably. For the recommended maximum power of the PV array for the charge controller, see *Table 5 on page 27*.

Table 5 PV Array Maximum Power

	Rated Charge Current	Rated Charge Power	Max PV Array Power	Max PV Open Circuit Voltage
Xantrex SOLAR MPPT Charge Controller	30A	390W/12V	580W/12V	92V ¹
	30A	780W/24V	1170W/24V	100V ²

¹ 25°C ambient temperature

² Minimum operating ambient temperature

Wiring Requirements

WARNING

ELECTRICAL SHOCK AND FIRE HAZARD

- All wiring should be done by qualified personnel to ensure compliance with all applicable installation codes and regulations. Design the power system using a certified recreational vehicle and PV system designer and install using a certified RV technician/electrician.
- Comply with all applicable installation codes and regulations.
- Do not connect to power sources during installation.

Failure to follow these instructions can result in death, serious injury, or equipment damage

WARNING

ELECTRICAL SHOCK HAZARD

Use a torque screwdriver to tighten the screw terminals on the charge controller to 10.6 lb-in (1.2 N-m) torque to ensure a proper connection.

Failure to follow these instructions can result in death, serious injury, or equipment damage.

NOTICE

REVERSE POLARITY

- Check polarity at all terminals before making the final DC connection. Pos(+) (red) must connect to pos(+) (red); Neg(-) (black) must connect to neg(-) (black)
- Reversing the pos(+) (red) and neg(-) (black) battery cables may blow the fuse.

Failure to follow these instructions can result in equipment damage.

Output power from the PV array varies depending on PV module size, connection method, or sunlight angle, the minimum wire size may be calculated using the short circuit current rating (I_{sc}^3) of the PV array. Refer to the value of I_{sc} in the manufacturer's PV module data specification sheet.

NOTE: The total I_{sc} of the PV array multiplied by 1.25 (a 25% safety factor) must not exceed the charge controller's rating of 30A.

Refer to *Table 6* for sizing PV and battery wires.

Table 6 Wiring Sizes

	Maximum PV input current	Minimum Wire Size	Maximum Wire Size
PV Wiring (to fit the terminals)	30A	10AWG	6AWG
Battery Wiring	30A	10AWG	6AWG

³ Multiplied by 125 % per the NEC, Article 690

Mounting Requirements

WARNING

ELECTRICAL SHOCK AND FIRE HAZARD

Do not cover or obstruct ventilation openings and/or heat sink. Do not mount in a zero-clearance compartment. Overheating may result.

Failure to follow these instructions can result in death, serious injury, or equipment damage

The charge controller should only be installed in locations that meet the following requirements:

Dry, Indoor	Do not allow water or other fluids to drip or splash on the charge controller.
Cool	Ambient air temperature should be between 0 °C and 40 °C (32 °F and 104 °F)—the cooler the better within this range.
Ventilated	Allow at least 15 cm (10 inches) of clearance at the top and bottom edges of the charge controller for air flow. Ensure that ventilation openings and heatsink or back plane on the unit are not obstructed.
Safe	Do not install the charge controller in the same compartment as batteries or in any compartment capable of storing flammable liquids like gasoline.
Close to the battery	Do not use excessive DC cable lengths: they increase wire resistance and reduce input power.
Protected from battery gases	Do not mount the charge controller where it will be exposed to gases produced by the batteries or where ignition protection is required. These gases are very corrosive and prolonged exposure will damage the equipment.
Wall mounting	Choose a wall location that is accessible, close to the battery, but well-ventilated. See <i>Mounting Dimensions on page 58</i> for the mounting template.

Basic Installation Steps

WARNING

HAZARD OF ELECTRIC SHOCK AND FIRE

- User shall install a fuse that is the same as the rated current of the controller on the positive battery side with a distance from the battery not greater than 150 mm.
- Ensure that the "+" and "-" poles on both the battery and PV are connected properly.
- Intended for indoor dry locations only.
- Do not install in Ignition Protection required area.
- Do not charge a frozen battery.
- Minimum charge ambient for Li-ion batteries is 0 °C (32 °F).

Failure to follow these instructions can result in death, serious injury, or equipment damage.

CAUTION

EQUIPMENT DAMAGE

Do not integrate this charge controller with a residential electrical system.

Failure to follow these instructions can result in injury or equipment damage.

1. Prepare the tools for installation.
 - #2 Phillips torque screwdriver
 - keyhole saw
 - pencil and ruler

- power drill with bit set (see NOTE)
- other tools such as wire stripper, cutter, crimper, wrench

Figure 4 Wall-mounting instructions

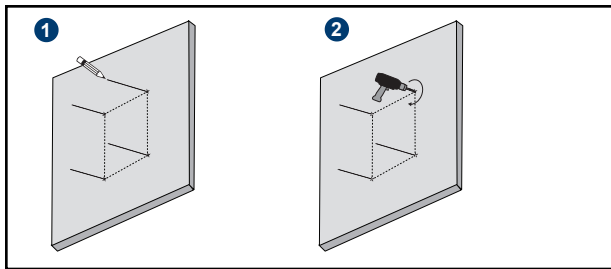

1 With the mounting dimensions shown at the end of this guide, a pencil and a ruler, mark the positions of the mounting holes in the wall.

2 Pre-drill the holes that were marked.

NOTE: For drilling on hard wood use bit size 1/16 and on soft wood use bit size 3/64

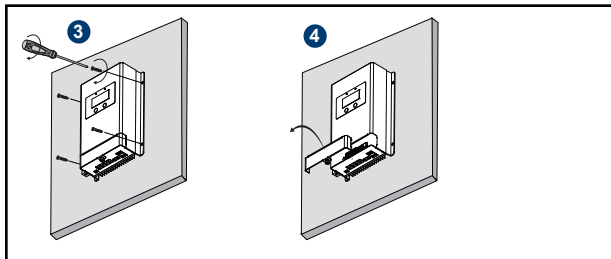

3 Using the provided mounting screws, secure the charge controller on the wall.

4 Remove the wiring terminals cover plate at the bottom of the unit and connect the cables/wires using *Figure 5* as an illustration and the instructions in step 2 (see details on page 34).

Figure 5 Wiring connections diagram

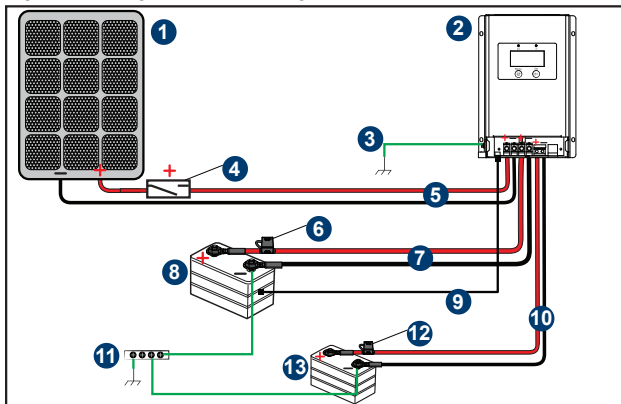

1	Solar panel	8	Battery 1
2	30A MPPT Solar Charge Controller (12/24VDC)	9	BTS cable on primary House battery
3	DC equipment ground	10	Battery [+] / [-] cables between 30A MPPT Solar Charge Controller (12/24VDC) and Battery 2
4	PV [+] cable with PV disconnect between 30A MPPT Solar Charge Controller (12/24VDC) and PV panel	11	DC Battery ground bus / vehicle chassis
5	PV [-] cables between 30A MPPT Solar Charge Controller (12/24VDC) and PV panel	12	Battery 2 DC fuse in Battery 2 [+] cable
6	Battery 1 DC fuse in Battery 1 [+] cable	13	Battery 2
7	Battery [+] / [-] cables between 30A MPPT Solar Charge Controller (12/24VDC) and Battery 1		

2. Connect the cables in the following sequence: Battery cables, PV cables, ground, and accessories, if applicable.

Battery cables

- a. Remove the DC fuse from the fuse holder on the red pos(+) battery cable.
- b. Connect the battery's red pos(+) cable to the charge controller's pos(+) terminal.
- c. Connect the battery's black neg(-) cable to the charge controller's neg(-) terminal.
- d. Connect the battery's red pos(+) cable to the battery's pos(+) terminal.
- e. Connect the battery's black neg(-) cable to the battery's neg(-) terminal.

NOTE: Follow the same instructions for the second battery bank. Both battery banks must be of the same chemistry.

IMPORTANT: Always follow the battery manufacturer's recommendations. Follow the stacking order of terminal connections (see *Figure 6*) and torque values for tightening nuts (or bolts). Do not configure Lithium-ion batteries.

Figure 6 Battery terminal stacking

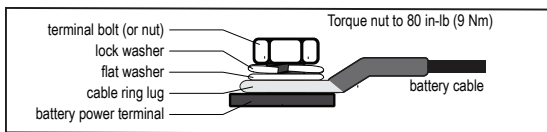

PV cables

- a. Cover the solar panel with a blanket to avoid energizing the cables.
- b. Install a PV Disconnect device on the red pos(+) PV cable. Install it closer to the solar panel's pos(+) terminal. Keep it open.
- c. Connect the red pos(+) PV cable with an open PV disconnect device to solar panel's pos(+) terminal and the charge controller's PV pos(+) terminal.
- d. Connect the black neg(-) PV cable to the solar panel's neg (-) terminal and the charge controller's PV neg(-) terminal.

Ground

- a. The charge controller is a common-negative charge controller, where all the negative terminals of the PV array and battery can be grounded simultaneously or just any one of them.

However, in some practical applications, all negative terminals of the PV array and battery can also be ungrounded. If this is the case, the grounding terminal on the charge controller must be grounded, which may prevent electromagnetic interference from the environment and also prevent personal injury due to electric shock.

Accessory

- a. Attach the Battery Temperature Sensor -BTS (PN: 708-0080)'s lead to the lead-acid house battery case.
- b. Connect the BTS cable to the charge controller's BTS terminal.

NOTE: To prolong the life of lead-acid batteries, the charge controller uses an algorithm in conjunction with the optional BTS to compensate for battery temperature fluctuations. This means, charging parameters are automatically adjusted for an efficient charging of the lead-acid battery.

3. Power up the system. When energizing or de-energizing the system, always follow the proper sequence.

Energize

- a. If BAT 2 is installed, then insert the DC fuse in the fuse holder on the battery's red pos(+) cable of BAT 2. Otherwise, proceed to the next step.

IMPORTANT: BAT2, if installed, must be energized first before BAT 1 in order for the charge controller to detect system voltage correctly.

- b. Insert the DC fuse in the fuse holder on the battery's red pos(+) cable of BAT 1.

IMPORTANT: BAT 1 must be energized whether or not BAT2 is installed for the charge controller to operate.

- c. Close the PV Disconnect device on the red pos(+) PV cable.
- d. Remove the blanket covering the solar panel.

De-energize

- a. Cover the solar panel with a blanket.
- b. Open the PV Disconnect device on the red pos(+) PV cable.
- c. Remove the DC fuse from the fuse holder on the battery's red pos(+) cable of BAT 1.
- d. If BAT 2 is installed, remove the DC fuse from the fuse holder on the battery's red pos(+) cable of BAT 2.

3 OPERATION

This chapter explains how to operate the solar charge controller and includes the following topics:

LCD Display Panel	38
Function Buttons and LED Indicators	38
Event Indicators	40
Basic Operation	41
Automatic Browsing Status Screens	46
Battery Status and Types	47
Protection Features During Operation	49

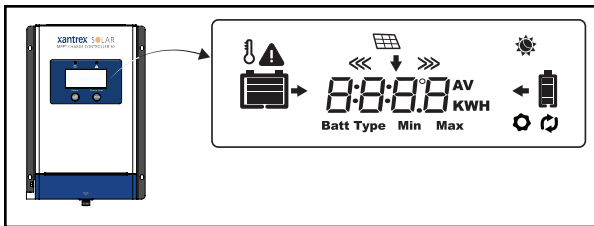

LCD Display Panel

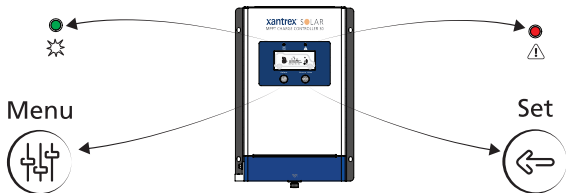

Function Buttons and LED Indicators



























Item	Button/LED	Description
MENU button		<p>Allows you to:</p> <ul style="list-style-type: none"> select parameters for PV Array select parameters for BAT1 select parameters for BAT2 select automatic browsing of status screens

Item	Button/LED	Description
SET button		<p>Allows you to:</p> <ul style="list-style-type: none"> • browse parameters for PV Array • browse parameters for BAT1 • browse parameters for BAT2 • configure the temperature unit • configure the battery type
PV Charging LED		Shows PV charging status.
Event LED		Shows a warning, error, or ground fault.

Event Indicators

NOTE: When an event is detected the LED indicators flash and the individual icons on the LCD Display also flash. For instructions on troubleshooting, see *Common Issues* on page 52.

Event LED	Charging LED	LCD Icon/s	Event Description
 red flashing 	 OFF 	 	Over-charging event on BAT1
 OFF 	 OFF 	 	BAT1 discharged
 red flashing 	 OFF 	 	Over-temperature event on BAT1
 red flashing 	 green flashing 	 	BAT1 charging voltage outside of range

Basic Operation

To browse different devices and their settings:









- Press  repeatedly to display each device screen.

Table 7 Device screen









LCD Icon	Device
	Remote panel's automatic status display
	BAT1 settings
	PV array settings
	BAT2 settings

To enable automatic status display:

- Press  once to display *Auto*.
- Press and hold  for 5 seconds until  appears. After 2 seconds each device setting will be displayed in sequence every 2 seconds. See *Automatic Browsing Status Screens on page 46*.

NOTE: Pressing  subsequently will disable automatic status display. To enable it again, perform step 2 again.

To change the temperature unit setting:

1. Press  repeatedly until the BAT1  device screen is displayed.
2. Press  repeatedly until the temperature, the  icon, and the  icon are displayed.
3. Press and hold  for 5 seconds until the temperature value changes and flashes to *dE9C* (or *dE9F*).
4. Press  to browse the desired temperature unit (*dE9C* or *dE9F*), then press  to confirm your selection.

To change the battery type setting:









1. Press  repeatedly until the BAT1 
or BAT2  device screen is displayed.
2. Press  repeatedly until the current battery type, the **Batt Type** icon, and the  icon are displayed.
3. Press and hold  for 5 seconds until the current battery type flashes.
4. Press  to browse the desired battery type (see *Table 8* for more on battery types), then press  to confirm your selection.

Table 8 Battery Types

LCD	Description
SEL 1	12V Sealed (AGM) battery type
SEL 2	24V Sealed (AGM) battery type
GEL 1	12V Gel battery type
GEL 2	24V Gel battery type
FLD 1	12V Flooded battery type







LCD	Description
FLd2	24V Flooded battery type
LFP1	12V 4-Cell Lithium-ion phosphate battery type
LFP2	24V 8-Cell Lithium-ion phosphate battery type

Depending on the battery type, these voltage settings are set according to charging stages.

Table 9 Battery Voltage Default Settings

Parameter	Default			
	5EL1 (12V AGM)	6EL1 (12V Gel)	FLd1 (12V Flooded)	LFP1 (LiFePO ₄ 4-cell)
Over-voltage fault	16V	16V	16V	14.8V
Maximum charge voltage	15V	15V	15V	14.6V
Over-voltage fault recovery	15V	15V	15V	14.5V
Equalize voltage	14.6V	--	14.8V	14.4V
Absorption voltage	14.4V	14.2V	14.6V	14.4V
Float voltage	13.8V	13.8V	13.8V	13.4V
Re-bulk voltage	13.2V	13.2V	13.2V	13.3V
Absorption time	120m	120m	120m	30m
Equalize time	120m	--	120m	30m
Temperature compensation coefficient (mV/C/2V)	-3	-3	-3	0
	NOTE: For 24V lead-acid batteries, multiply the voltage here by two.			NOTE: For 24V 8-cell battery multiply the voltage here by 2.

To reset the PV Harvest:

1. Press  repeatedly until the PV  device screen is displayed.
2. Press  repeatedly until the cumulative PV Harvest status screen  is displayed.
3. Simultaneously, press and hold   buttons for 5 seconds until the PV Harvest value is reset to **0WH**.

Automatic Browsing Status Screens

NOTE: To set automatic browsing, see *Basic Operation on page 41*

Start



Shows input PV voltage.



Shows input PV current.



Shows input PV power.



Shows cumulative PV Harvest in watt-hours.



Shows BAT1 voltage.



Shows BAT1 current.



Shows BAT1 max. voltage.



Shows BAT1 min. voltage.



Shows BAT1 battery temp..



Shows BAT1 Battery type.



Shows BAT2 voltage.



Shows BAT2 current.



Shows BAT2 max. voltage.

























Shows BAT2 min. voltage.

starting screen

Battery Status and Types

Table 10 Battery Status

Icon	Description	Icon	Description
	BAT1 SOC 0~12%		BAT2 SOC 0~12%
	BAT1 SOC 13~35%		BAT2 SOC 13~35%
	BAT1 SOC 36~61%		BAT2 SOC 36~61%
	BAT1 SOC 62~86%		BAT2 SOC 62~86%
	BAT1 SOC 87~100%		BAT2 SOC 87~100%
	BAT1 Charging		BAT2 Charging
	Daytime		Nighttime
	Display BAT1 parameters		Display BAT2 parameters
	PV Panel		Display PV parameters

Icon	Description	Icon	Description
	BAT1 temperature	Batt Type	Battery type
	Settings (Parameters)	Min	Minimum voltage
	Auto screen cycle	Max	Maximum voltage
	Event		

Protection Features During Operation

NOTE: When an event is detected the LED indicators flash and the individual icons on the LCD Display also flash.

Event	Event Description
PV over-current	When the PV array's charging current exceeds the charge controller's rated current, the charge controller will charge at its rated current.
PV short circuit	The charge controller will not be damaged in case of a short-circuit event in the PV array.
PV reverse polarity	The charge controller will not function but remains undamaged. Correct the reverse polarity and the charge controller will operate normally. However, if the PV array is reverse connected to the charge controller and energized at 1.5 times the rated charge controller power then the charge controller may become damaged.
Reverse charging	The charge controller prevents the battery from reverse charging to the PV array during nighttime or blocked sun situations.
Battery reverse polarity	The charge controller will prevent the battery from damage when the cable connections are reversed. Correct the reverse polarity and the charge controller will operate normally. If a Lithium-ion battery is used then there is no reverse polarity protection.
Battery (BAT1) over-voltage	The charge controller will stop charging when the battery reaches the over-voltage disconnect setpoint to prevent battery damage.
Battery (BAT1) over-discharge	When battery voltage reaches the low voltage disconnect (LVD) voltage, the unit will automatically stop discharging the battery to prevent battery damage. However, any DC load directly connected to the battery will continue to discharge the battery.
Battery (BAT1) over-temperature	In conjunction with the optional Battery Temperature Sensor -BTS (PN: 708-0080), the charge controller will stop charging when the battery temperature exceeds 65 °C. It will return to normal operation when battery temperature cools down to 55 °C.

Event	Event Description
Lithium-type Battery (BAT1) low temperature	When the Lithium-type battery temperature detected by the optional temperature sensor is lower than the Low Temperature Protection Threshold (LTPT), the charge controller will stop charging and discharging automatically. When the detected temperature is higher than the LTPT, the controller works automatically. The LTPT is 0 °C by default and can be set within the range of 10 ~ -40 °C.
Charge controller over-temperature	The charge controller will stop charging when the charge controller's internal temperature exceeds 85 °C. It will return to normal operation when its internal temperature cools down to 75 °C.
Transient voltage	The charge controller has TVS (transient voltage suppressor) protection which can withstand low energy surges. In environments where lightning is frequent, you are recommended to install a lightning arrester.

4 TROUBLESHOOTING

This chapter includes the following topics:

Common Issues	52
Maintenance	53

WARNING

ELECTRICAL SHOCK HAZARD

























Do not disassemble the charge controller. It does not contain any user-serviceable parts. Attempting to service the unit yourself could result in an electrical shock or burn.



Failure to follow these instructions can result in death, serious injury, or equipment damage.

NOTE: To obtain service go to *Contact Information on page 1.*

Common Issues

NOTE: When an event is detected the LED indicators flash and the individual icons on the LCD Display also flash.

Event LED	Charging LED	LCD Icon/s	Problem	Solution
 red flashing 	 OFF 	 	Over-voltage event on BAT1	Check if the battery voltage is exceeding the over voltage disconnect point and disconnect the PV.
 OFF 	 OFF 	 	BAT1 discharged	Charge the battery as soon as possible.
 red flashing 	 OFF 	 	Over-temperature event on BAT1	The charge controller will stop charging the battery above 65 °C. Charging will resume when the battery temperature cools down to 55 °C below.
 red flashing 	 green flashing 	 	BAT1 charging voltage outside of range	Check if the actual battery type is compatible with the charge controller's battery type's charging voltage. If not, change the battery type setting to match the actual battery type. See <i>Battery Status and Types</i> on page 47.

Event LED	Charging LED	LCD Icon/s	Problem	Solution
 OFF	 OFF	LCD is off	No power.	Check if there is a connection to the battery. Check the fuse on the battery cable.
			Battery voltage is less than 8.5V.	Charge the battery as soon as possible to more than 8.5V.

Maintenance

NOTE: Perform these inspections at least two times per year.

- Make sure the charge controller remains in a dry environment.
- Clean up any accumulated dust or dirt on the unit.
- Check all the wires and cables for insulation damaged. Repair or replace, if necessary.
- Tighten all terminal connections to the correct torque values, if applicable. Inspect for loose or broken wire connections.
- Confirm that all terminals are free from corrosion
- If installed in the system, check and confirm that the lightning arrestor is in good condition. Replace, if necessary.

This page is intentionally blank.

5 SPECIFICATIONS

NOTE: Specifications are subject to change without prior notice.

Torque Specifications for Fasteners

30A charge controller terminal screws	10.6 lb-in (1.2 N-m)
--	----------------------

Specifications	30A MPPT Solar Charge Controller (12/24VDC)
Part number	710-3024-01
Nominal System voltage	12/24 VDC
BAT 1 Rated charge current	30 A @ 55 °C
BAT 2 Rated output	1 A, 13.8/27.6 VDC
Max PV open circuit voltage	100 VDC
Battery type	Sealed (AGM) / Gel / Flooded / LiFePO ₄
Battery output voltage range	9–32 VDC
Unit weight	550 g (1.2 lbs.)
Physical dimensions	181 × 101 × 60 mm (7.1 × 4.0 × 2.4 inches)

Specifications	30A MPPT Solar Charge Controller (12/24VDC)
Protection features	Solar panel reverse polarity, short-circuit Battery reverse polarity / over-temperature / overload / short-circuit
Wire terminals	up to 6 AWG
No load loss	< 30 mA
Equalize charging interval	30 days (Flooded lead-acid battery)
Operating temperature	-20 – 45 °C (-4 – 113 °F)
Storage temperature	-30 – 80 °C (-22 – 158 °F)
Relative humidity	≤ 95% (non-condensing)
IP protection	IP33
Temperature compensation	-3.0 mV/°C/2V

Accessory List

Accessories (Sold Separately). Contact a Xantrex authorized dealer to order.

Battery Temperature Sensor -BTS (PN: 708-0080)

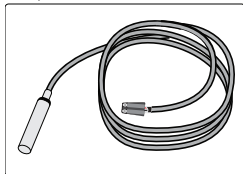

SOLAR MPPT Remote Panel (PN:710-0010)



Mounting Dimensions

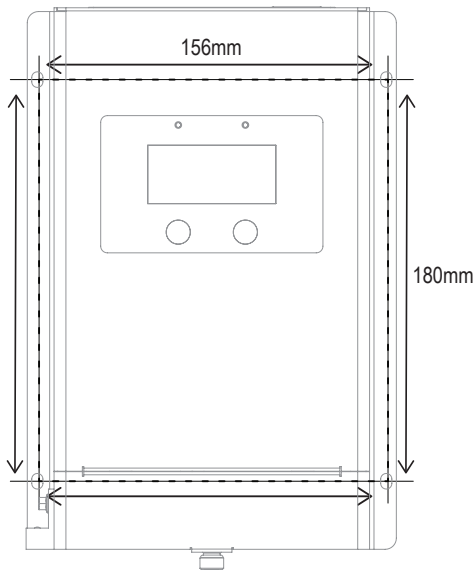

NOTE: Illustration is not to scale. Represents only distances between the mounting holes.

This page has no content.

xantrex™ SOLAR



+1-800-670-0707

+1-408-987-6030



customerservice@xantrex.com

<http://www.xantrex.com/power-products-support/>



<http://www.xantrex.com>