

## TRUECHARGE3 BATTERY CHARGER DATASHEET







AVAILABLE IN:  
**20A/12V**  
**40A/12V**  
**60A/12V**

### ULTRA-COMPACT, HIGH PERFORMANCE CHARGER FOR WORLDWIDE CHARGING

TRUEcharge3 battery chargers lead the industry with a small footprint and ultra-compact design. In addition to meeting global safety and regulatory standards, TRUEcharge3 battery chargers feature low electrical interference and efficient, power factor corrected multistage charging. Thanks to their inherent drip-proof design characteristics, the TRUEcharge3 chargers can be mounted in multiple positions. Unlike its predecessors, **TRUEcharge3 is Lithium-ion battery compatible.**

Designed for recreational and commercial applications worldwide, TRUEcharge3 accepts 90–265 Vac, 47–63 Hz which makes traveling abroad and handling poor-quality power a breeze. The easy-to-read display of the TRUEcharge3 12 V models can be augmented with an optional remote panel. Each models comes with built-in protection against surges and spikes on the AC power line.

-  Lithium-ion Battery Compatible
-  Automatic 3-stage Battery Charger
-  Parallel Stacking for up to Two Chargers
-  Higher Quality & Reliability

APPLICATIONS:



[www.xantrex.com](http://www.xantrex.com)  
CUSTOMER CARE: 1.800.670.0707

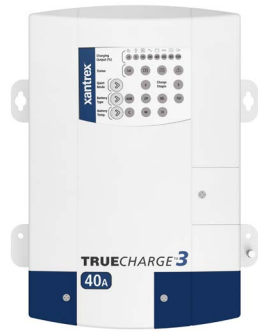

FRONT VIEW

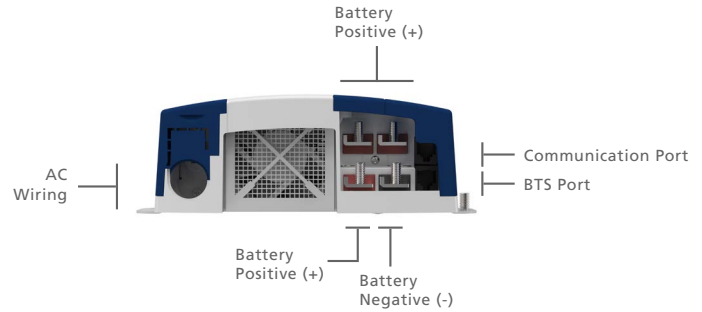

BOTTOM VIEW

## PRODUCT FEATURES

- Equipped with parallel stacking (remote panel required)
- Microprocessor-controlled, multistage charging algorithms
- Settings for two and three-stage charging
- Settings for flooded, gel, AGM or Lithium-ion batteries
- Battery-equalization feature
- Ability to charge batteries drained to extremely low voltage
- Added quiet mode

## PROTECTION FEATURES

- Reverse battery polarity protection
- Drip-proof design
- DC over-voltage protection
- Over temperature protection
- Circuit breaker protection

## THREE-STAGE CHARGING

Multistage charging ensures batteries receive optimum charging, but with minimal wear and tear, regulating the voltage and current delivered to the batteries in three automatic stages:

- Bulk: Replaces 70–80% of the battery's state-of-charge at the fastest possible rate
- Absorption: Replenishes the remaining 20–30% of charge, bringing the battery to a full charge at a slow, safe rate
- Float: Voltage is reduced and held constant in order to prevent damage and maintain batteries at a full charge the remaining 20–30% of charge, bringing the battery to a full charge at a slow, safe rate

## POWER FACTOR CORRECTED (PFC) CHARGING

Less shorepower is required for charging batteries, freeing up more usable AC power for running electrical devices and appliances and reducing the likelihood of tripping shorepower breakers

### TRUECHARGE3 BATTERY CHARGER DIMENSIONS

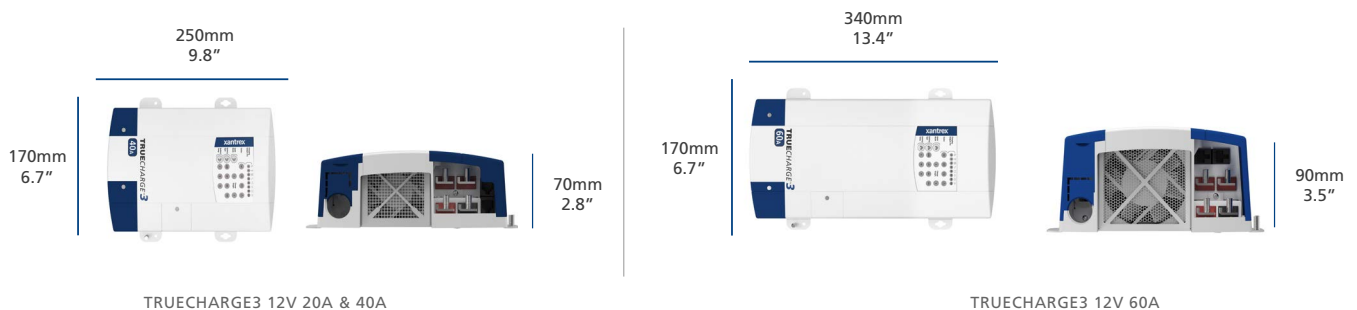

**ELECTRICAL SPECIFICATIONS (@ 25°C unless otherwise noted)**

	TRUEcharge3 20	TRUEcharge3 40	TRUEcharge3 60
Output Current (nominal)	20 A	40 A	60 A
Output Voltage (nominal, depending on settings)			
Charge	14.2–15.5 Vdc	14.2–5.5 Vdc	14.2–15.5 Vdc
Float	13.4–13.8 Vdc	13.4–13.8 Vdc	13.4–13.8 Vdc
Equalize	16 V	16 V	16 V
DC Output Connections	Three	Three	Three
AC Input Voltage*	90–265 Vac; 47–63 Hz 120 Vac, 230 Vac, 240 Vac nominal	90–265 Vac; 47–63 Hz 120 Vac, 230 Vac, 240 Vac nominal	90–265 Vac; 47–63 Hz 120 Vac, 230 Vac, 240 Vac nominal
Temperature Compensation	Three settings	Three settings	Three settings
Charger Efficiency	> 80%	> 80%	> 80%
Battery Type	Gel, Flooded, AGM, LiFePO <sub>4</sub>	Gel, Flooded, AGM, LiFePO <sub>4</sub>	Gel, Flooded, AGM, LiFePO <sub>4</sub>
Minimum Recommended Battery Bank Size	40 Ah	80 Ah	120 Ah

**GENERAL SPECIFICATIONS**

	TRUEcharge3 20	TRUEcharge3 40	TRUEcharge3 60
Operating Temperature Range**	0–60°C (32–140°F)	0–60°C (32–140°F)	0–60°C (32–140°F)
Storage Temperature	-40–80°C (-40–176°F)	-40–80°C (-40–176°F)	-40–80°C (-40–176°F)
Battery Connection	Three positive terminals One negative terminal	Three positive terminals One negative terminal	Three positive terminals One negative terminal
Dimensions (H x W x L)	70 x 170 x 250 mm (2.8 x 6.7 x 9.8")	70 x 170 x 250 mm (2.8 x 6.7 x 9.8")	90 x 170 x 340 mm (3.5 x 6.7 x 13.4")
Weight	2.2 kg (4.8 lb)	2.2 kg (4.8 lb)	4.5 kg (9.9 lb)
Part Number	804-1220-10	804-1240-10	804-1260-10

**REGULATORY APPROVALS**

Meets CSA 60335-2-29, CE Marked for the Low Voltage Directive (safety) and the EMC Directive, UL1564, IEC 60335-2-29, IP32 per EN.IEC 60529, FCC Part 158, Canada ICES-003 Class B emissions limits, ABYC A-31, and DOE/CEC energy efficiency compliant.

Specifications are subject to change without notice.  
Highly Accelerated Life Tested (HALT) to -20°C.

\*90 – 104Vac ± 4Vac output de-rated to 80% of full load current  
\*\*For all three models, the output current may derate above 50°C.

**ACCESSORIES**

Mfg Part #	Description
808-0232-01	BTS (battery temperature sensor)
808-8040-10	TRUEcharge3 Remote Panel

NOTE: Contact Xantrex or your dealer to order these accessories.

**CONTACT****CUSTOMER SERVICE**

1.800.670.0707  
customerservice@xantrex.com  
Hours of operation:  
6:30am - 4:30pm PST, Monday to Friday

 [facebook.com/Xantrex](https://www.facebook.com/Xantrex)

 @Xantrex

 [youtube.com/XantrexTechnology](https://www.youtube.com/XantrexTechnology)

**LEARN MORE ON:**

[www.xantrex.com](http://www.xantrex.com)